

CODE NUMBER

3315401BT

DESCRIPTION

Bluetooth, 8" Trim Plate, Battery Power Supply, Below Deck
Thermostatic Mixing Valve, Polished Chrome Finish, 0.5 gpm, Multi-
Laminar Spray, Infrared Sensor, Optima® Battery or Turbine-Powered
Deck-Mounted Low Body.

DETAILS

- Flow Rate: 0.5 gpm (1.9 Lpm) (0.5GPM)
- Spray Type: Multi-Laminar (MLM)
- Sensor Type: Infrared
- Mounting Type: Single Hole
- Mounting Size: Single Hole 1-1/4" to 1-1/2"
- Trim Plate: 8" (203mm) (8)
- Power Supply: Battery (BAT)
- Temperature Mixer: Below Deck Thermostatic Mixing Valve (BDT)
- Finish: Polished Chrome (CP)
- Factory Default Timeout: 30 seconds
- Factory Default Gallons per Cycle: 0.25

FEATURES

ADA Compliant, Water Usage and Battery Strength Reporting,
Wireless Settings Adjustment, Commercial Grade Faucet, Integrated
Water Shut-off, Hygienic Line Flush, On-demand or Metered
Activation, Self-adapting Sensor, Cast Brass Spout, Quick Connect
Fittings

ELECTRICAL SPECIFICATIONS

- Battery Life: 3 years 8,000 cycles/month
 - Optional power harvesting significantly extends service life
- Sensor Range: 4" - 5" (102 - 127mm)
- Timeout Adjustment Settings: 30s

POWER SUPPLY OPTIONS

- 6VDC Plug Adapter (sold separately), 0362006*
- * when converting units to hardwired with battery back-up

VIDEOS

- ▶ Sloan Optima Below Deck Faucet
- ▶ PVD Special Finishes
- ▶ Sloan Connect App®

DOWNLOADS

- [Optima Smart Faucet Below Deck Installation Instructions](#)
- [Faucet Spray Heads Repair and Maintenance Guide](#)
- [Optima EBF-415 / ETF-410 Repair & Maintenance Guide and Parts Breakdown](#)
- [Trim Plate Guide](#)
- [Additional Downloads](#)



Variation not shown: 8" Trim Plate

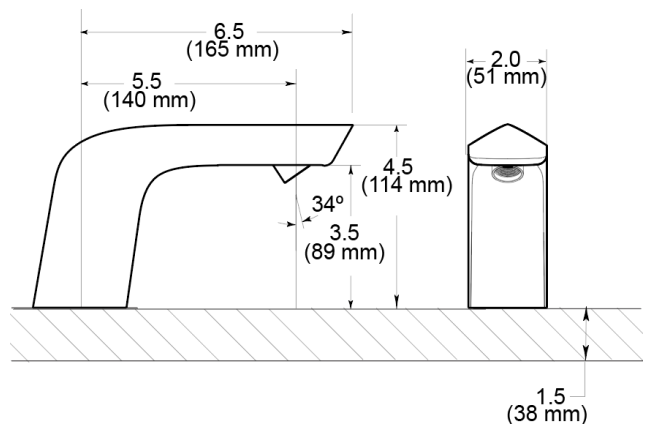

COMPLIANCES & CERTIFICATIONS



(ADA Compliant, ASME A112.18.1 Compliant, ASSE 1070, BAA Compliant, BREEAM Materials Credit, BREEAM Water Credit, CalGreen Compliant, CEC Compliant, cUPC Certified, UPC Certified, UPC Low Lead Compliant, cUPC Low Lead Compliant, EPD, Green Globes Materials & Resources Credit, Green Globes Water Credit, HPD, IAPMO, LEED Materials & Resources EPD Credit, LEED Materials & Resources HPD Credit, WaterSense Listed, NSF-61, NYC604.4, Proposition 65, Satisfies LEED Credits, TAS, WELL Building Standard)

Sloan 10500 Seymour Ave, Franklin Park, IL 60131

Phone: 800.982.5839 • Fax: 800.447.8329 • sloan.com

RECOMMENDED SPECIFICATION

Faucet shall include cast brass body, quick-connect fittings, twist-off/shut-off solenoid assembly, removable battery cartridge, flexible power supply and allow adjustment of settings wirelessly via Apple or Android smartphones.

NOTES

All information contained within this document subject to change without notice.

Looking for other variations of the EBF-415 product? [View the general spec sheet with all options.](#)

[Find a matching soap dispenser](#) for this faucet.

[Find a compatible sink](#) for this faucet.

WARRANTY

[View Warranty Information](#)

ROUGH-IN

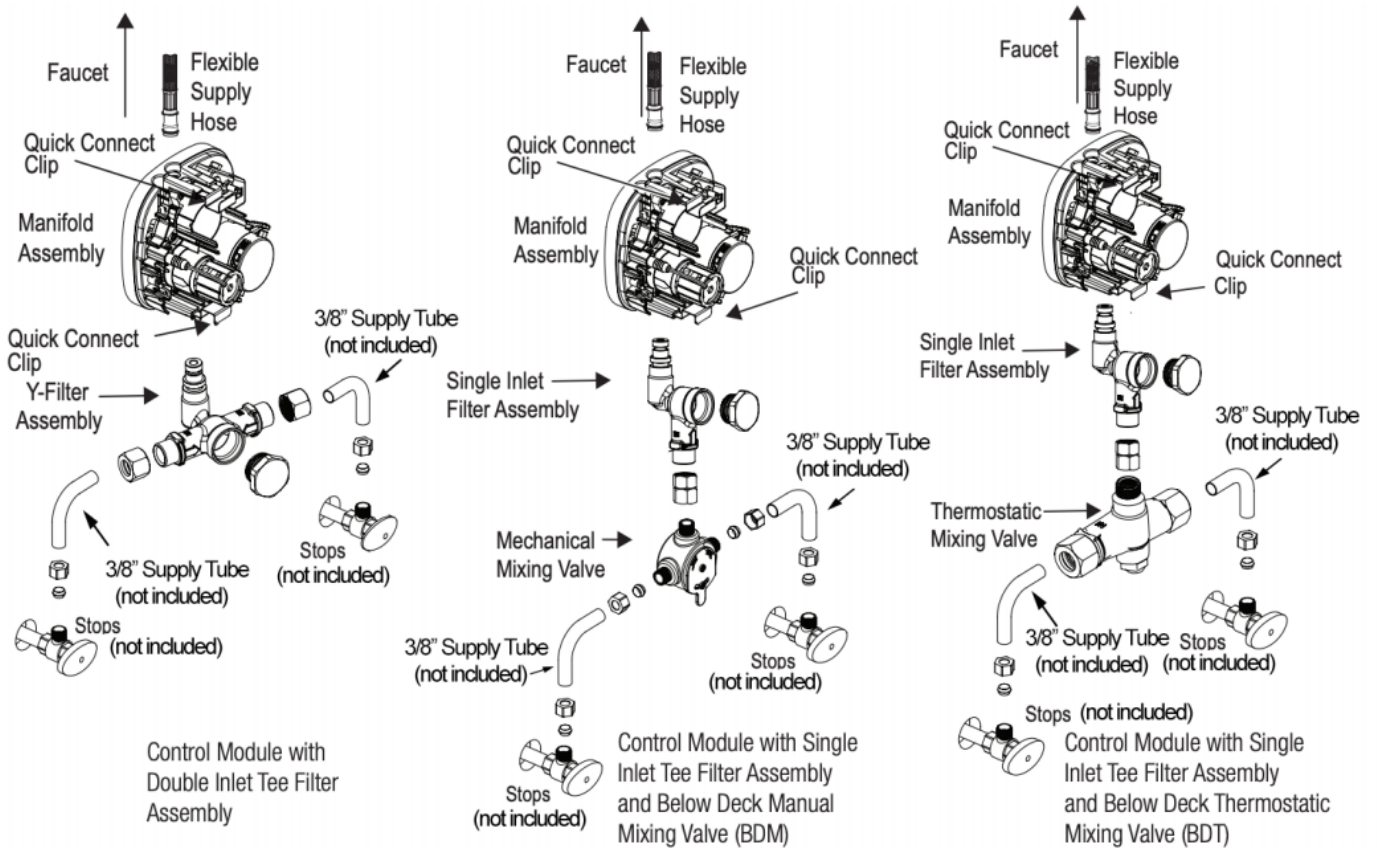

Sloan 10500 Seymour Ave, Franklin Park, IL 60131

Phone: 800.982.5839 • Fax: 800.447.8329 • sloan.com